

Honeywell



Honeywell



IS-6500 TCP/IP Video Door Phone System

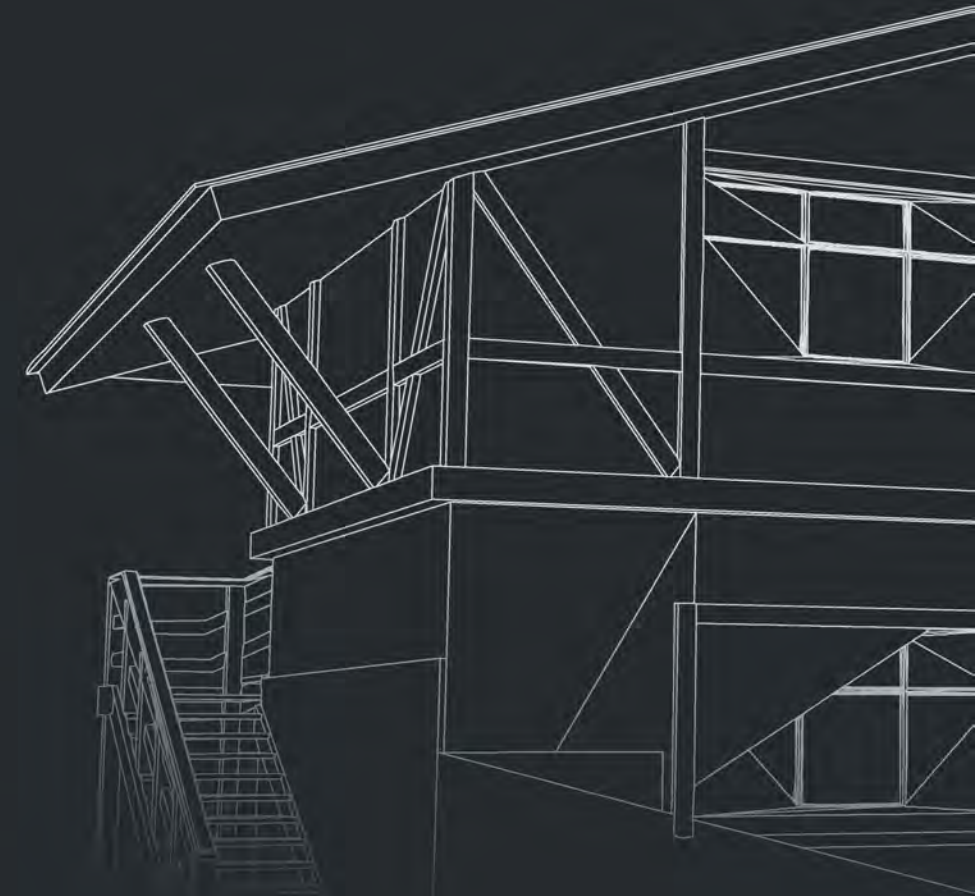
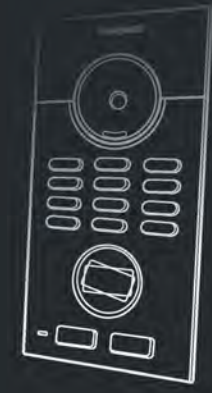
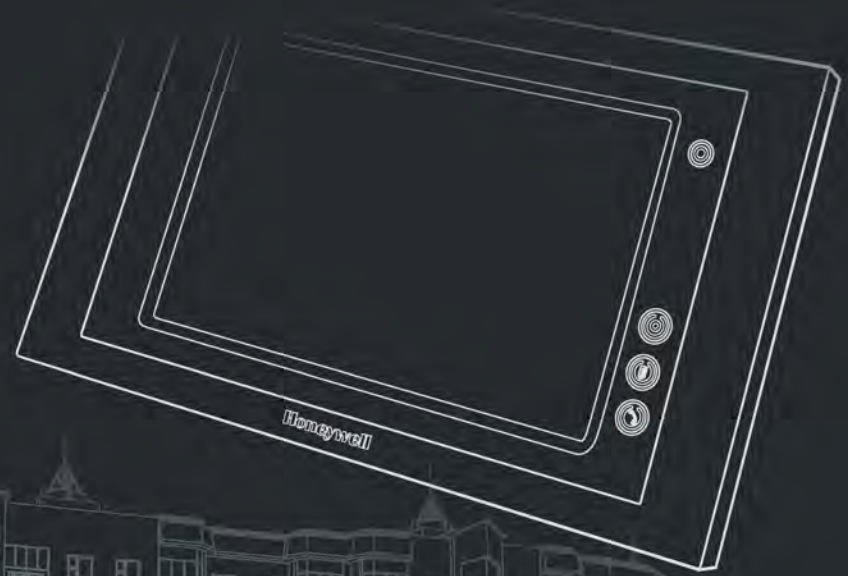



We are building a world that's safer and more secure...
More comfortable and energy efficient...
More innovative and productive.
We are Honeywell.

Glamorous Look

Stylish Design 20 mm ultra-slim streamlined curve design, a combination of modern luxury and simplicity.

Glass Panel Flat-screen vandal resistant glass, making scratches difficult to stay. Just a few wipes can bring a glossy surface back and provide a brilliant look everyday.

Quality Metal Gold and silver like metal matte paint coating. No matter what interior decorating style you have, it all fits very well. Absolutely a decorative work of art!

Honeywell



Refinement everywhere, from design to material and workmanship...



Celebrity Gold

Champagne gold is of noble retro style. Suitable for various interior designs: classical, neo-classical, neo-Chinese and European classical styles.



New Urban Silver

Platinum is of brilliant elegance, expressing low-pitched luxuriousness. Suitable for various interior designs: neo-classical, modern and Art Deco styles.

Blend of Classic Look and State-of-the-art Technology ...



Quality · Design

Capacitive Touch Screen Technology makes your operation more accurate, more responsive and more user-friendly.

Control Interface is wholly based on user experience, nice and user-friendly. Backgrounds, icons and structure layouts are extremely intuitive. Also, wallpapers can be changed to whatever you like. Everything is simple, easy and enjoyable!

The Honeywell logo is rendered in a light, glowing white font, appearing as if it's part of a technical drawing or blueprint. The background of the entire advertisement is a dark blue with white line art depicting various smart home components: a control panel with buttons and a screen, a circular device (possibly a camera or sensor), a rectangular device with a display, and architectural outlines of a house with windows and a staircase. The overall aesthetic is clean, technical, and futuristic.

Honeywell

Honeywell, a Global Leader of Automation Control and Smart Home Technology...

Reliable Performance

Century-manufacturing Techniques Hundred-year manufacturing process control standards from Honeywell, leveraging smart home core expertise technology to build an advanced, flexible and reliable digital visual intercom system.

High Compatibility IS-6500 is designed to be easily integrated in the near future with MoMas™ Honeywell Smart Home Systems like the HS-7000V Home Gateway system thus providing complex developers infinite possibilities of expandable intelligent community solutions.

Leading Security Technology Incorporates the professional-level intrusion alarm function to the intercom system to help create a safe community.

Left-Right: Offline Notice, Bulletins, New Visitor Records

Screen Lock for Cleaning

5 °C | Cloudy
22:38
2011-01-17 Monday
0-12 °C

Concurrent Weather Forecast And Time Updating

Security Scenario Shortcut



Tap to Call Security Guards and Management Center

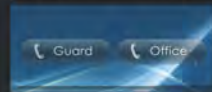

Key Function Shortcuts



Details Make Differences IS-6500

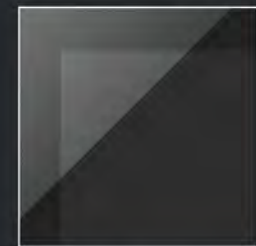

flat crystal screen

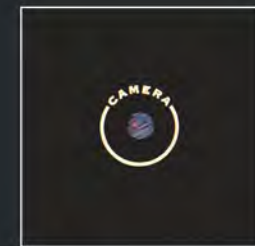

130 pixel camera



metal matte paint coating

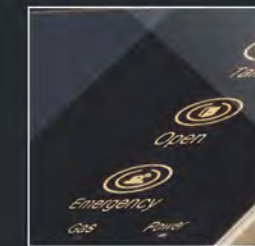

touch screen control button
top to bottom:
response/ open/ help

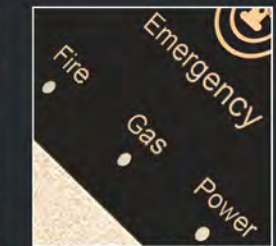

LED indicator,
left to right: fire (red), gas
(yellow), power (green)

matte treatment for
aluminum-alloy panel



empaistic and fiber
drawing Honeywell logo



micro SD card slot,
plug and play

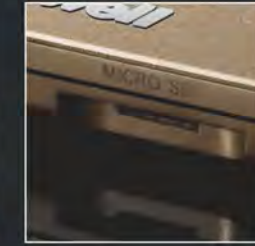

speakers



7 inch TFT LCD display
single capacitive touch
screen



IS-6500 Features Summary



Communication

- Communication between property owner and visitors
- Communication with neighbours
- Communication with property owners and security guards
- Inhouse inter-communication,
- Supports up to 8 subphones
- Door striker release and management center call (HSP-2000)
- Supports 2 door cameras
- Command center and building security guards communication
- Visitor triple identification (community/building/unit)
- Call forwarding and multi-level management
- Management center call shortcut on GUI

Security

- Security scenario customization: Away/Home/Sleep
- 6 customized security zones, 24-hour protection zones (fire/gas), 2 emergency buttons
- System self-diagnostics, alarm for abnormal zones
- Password and time delay setup
- Bypassed zone under Away scenario
- Alarm popup on GUI and onsite alarm buzzing
- Concurrent management center notification and alarm buzzing
- In emergency, 'Help 1' to notify security guards and management center with onsite alarm buzzing
- 'Help 2' to notify security guards and management center without onsite alarm buzzing
- Front and back monitoring through door cameras

Information Service

- Time, date and weather forecast
- 50 community messages (bulletins)
- 50 expense messages
- 50 my messages

Personalization

- Customization of ring tone and background (plug-and-play, SD memory card)
- Brightness and volume adjustment

Elevator Control

- Built-in elevator control relay
- Built-in elevator authorization relay

Storage

- Store up to 30 visitor photos for property owners and management center
- 3 away messages, 60 second each
- Home page visitor record and message notice

Access Control

- Electric door striker control
- Wireless door striker control

Gadget

- Screen lock for clean: automatic unlock when receiving incoming calls
- Offline self-diagnostics notice on user interface

IS-6500 Specifications

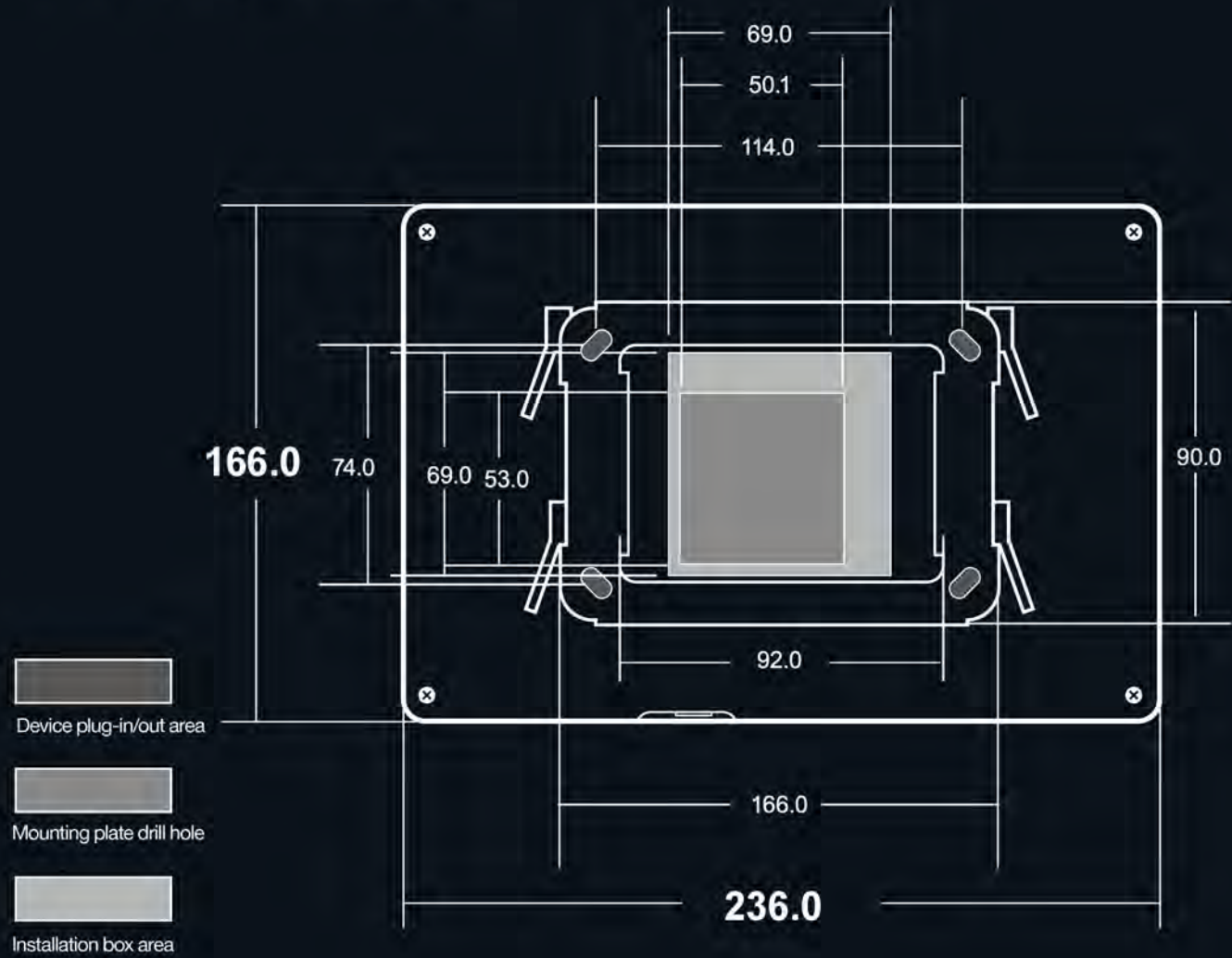

Connection Diagram

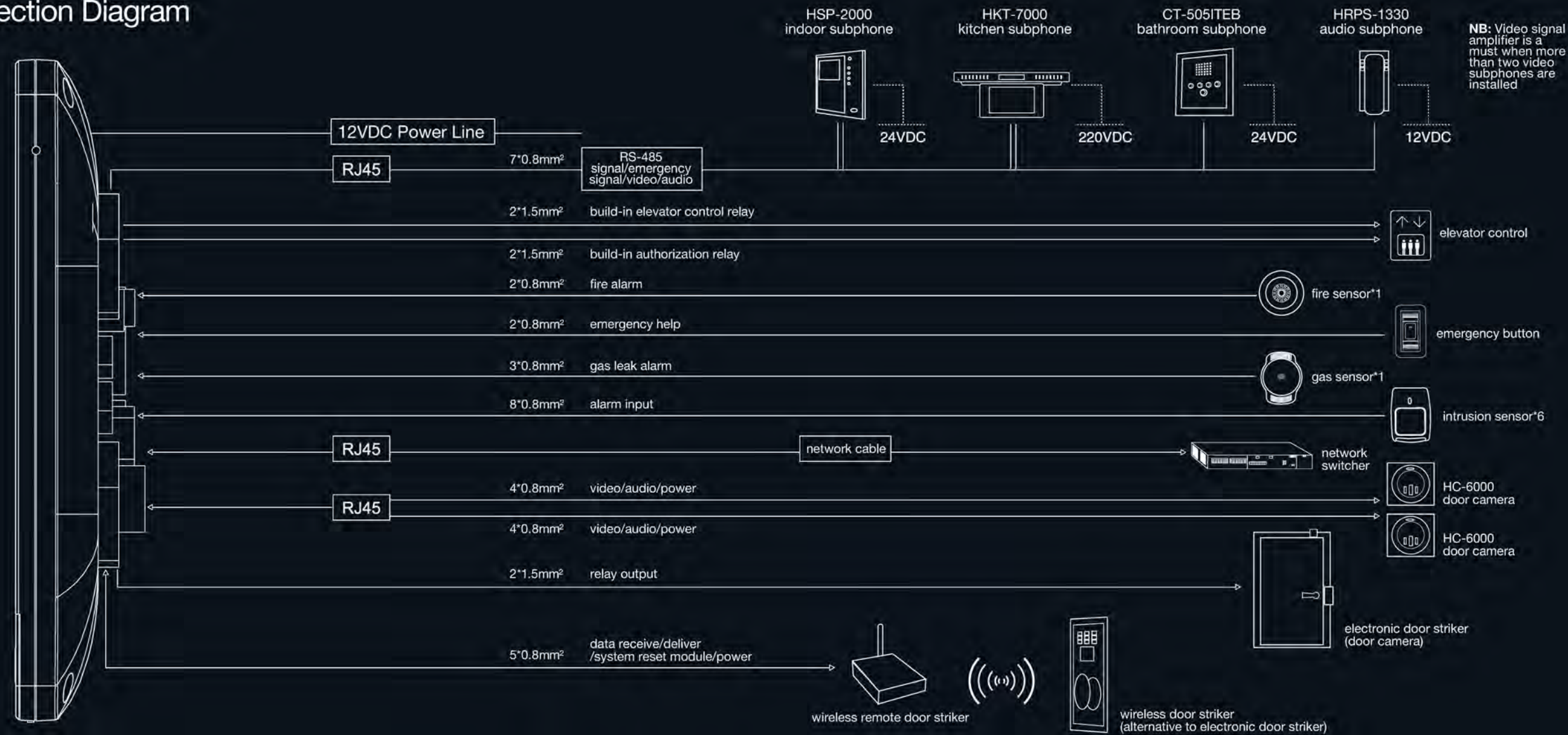

Internet Structure

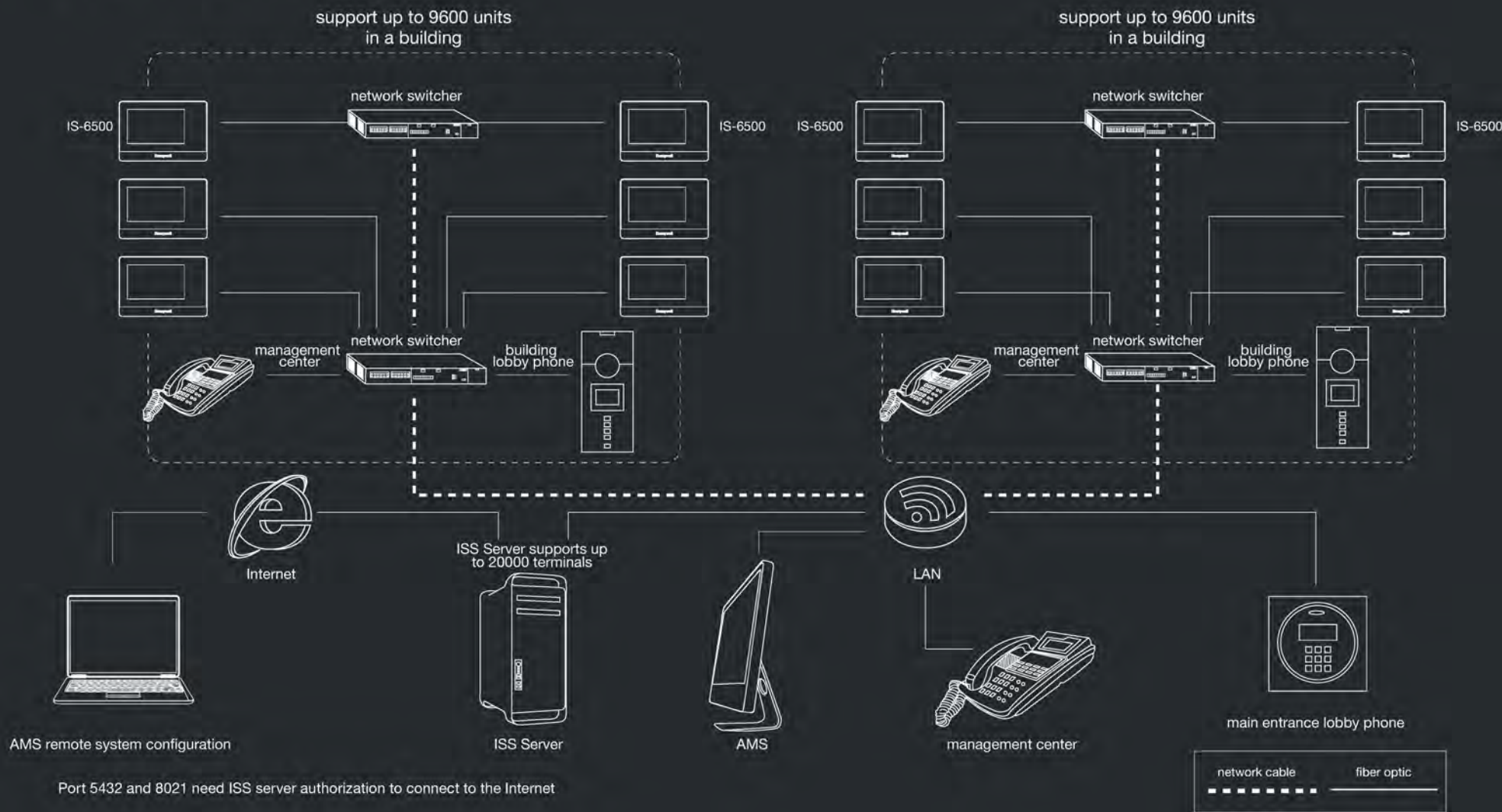

IS-6500

IS-6500-G IP Video Door Phone (celebrity gold), 7" TFT LCD
IS-6500-S IP Video Door Phone (new urban silver), 7" TFT LCD



Building Lobby Phone/Main Entrance Lobby Phone

HLP-1000VTM-EN-P IP color door camera (pure TCP/IP), digital password, with RF (Mifare 13.5MHz) card reader
HLP-3050VTM-EN-P IP color door camera (pure TCP/IP), 3.5" LCD display, digital password, with RF (Mifare 13.5MHz) card reader (coming soon)



Door Camera

HC-6000EN-A Color unit door camera, G-109201 connection required



Inhouse Subphones

HSP-2000 Subphone, color display, 5" TFT

HRPS-1330 Subphone (audio only), analog

HKT-7000-EN-P Kitchen television/phone 7" TFT LCD

CT-505ITEB Bathroom subphone (with phone call function)



Server and Management Software

ISS-EN-0300/0500/1000/3000/5000 IP VDP server software (including management center software and server software)

Recommend Sever Hardware Intel Quad Core CPU, 2GB RAM, expandable to 24GB; hard disk 320GB, giga byte ethernet interface

Operation System Windows Server 2003/2008, Enterprise x32/64

Database PostgreSQL8.3.10

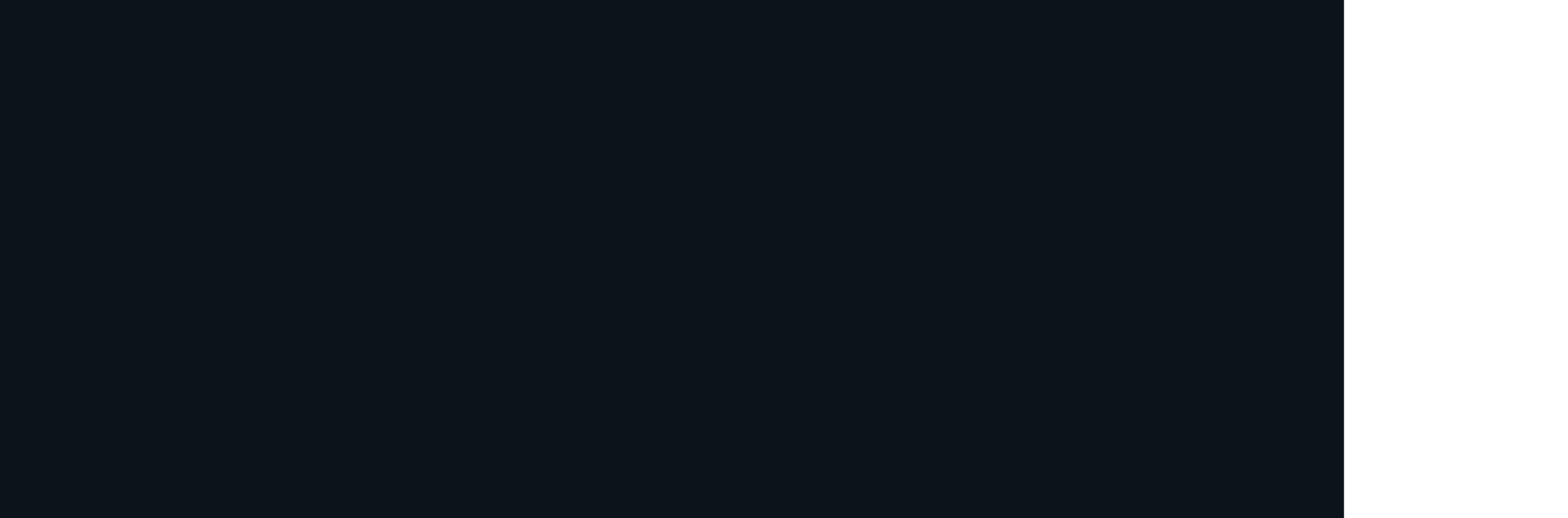

TCP/IP Video Door Phone System

For more information:

Security Asia Pacific Headquarters
Security Australia
Security Australia National Sales Hotline
Security China
Security China Customer Service Hotline

Tel: (86) 21-2219 6888
Tel: (61) 2-9353 7000
Tel: 1300 765 532
Tel: (86) 21-2219 6888
Tel: 400-8800-330

Security Hong Kong
Security India
Security Korea
Security Singapore
Security Taiwan

Tel: (852) 2405 2323
Tel: (91) 124 4975000
Tel: (82) 2-799 6130
Tel: (65) 6333 9563
Tel: (886) 2-2245 1000

www.asia.security.honeywell.com
security.ap@honeywell.com

Honeywell Security Group
Automation & Control Solutions
Honeywell International Inc.
www.security.honeywell.com

Aug 2011
© 2011 Honeywell International Inc.

Honeywell